

# GP Batteries

## PRODUCT SPECIFICATION

### USB 8-Slot Charging Dock Model : D851

#### Revision History

Revision	Date	Initiator	Reason for Change
0.0	27 Mar 2020	CC Li	Initial release

Prepared By	Approved By
CC Li	Vincent Lam
Date: 27 Mar 2020	Date: 27 Mar 2020

#### **GPI International Limited**

7/F, Building 16W, 16 Science Park West Avenue  
Hong Kong Science Park, New Territories, Hong Kong,  
Tel: (852) 2484 3333 Fax: (852) 24805912  
Email: [gpii@goldpeak.com](mailto:gpii@goldpeak.com)  
Website: <http://www.gpbatteries.com>

# GP Batteries

## Product Specification

Model no.: D851

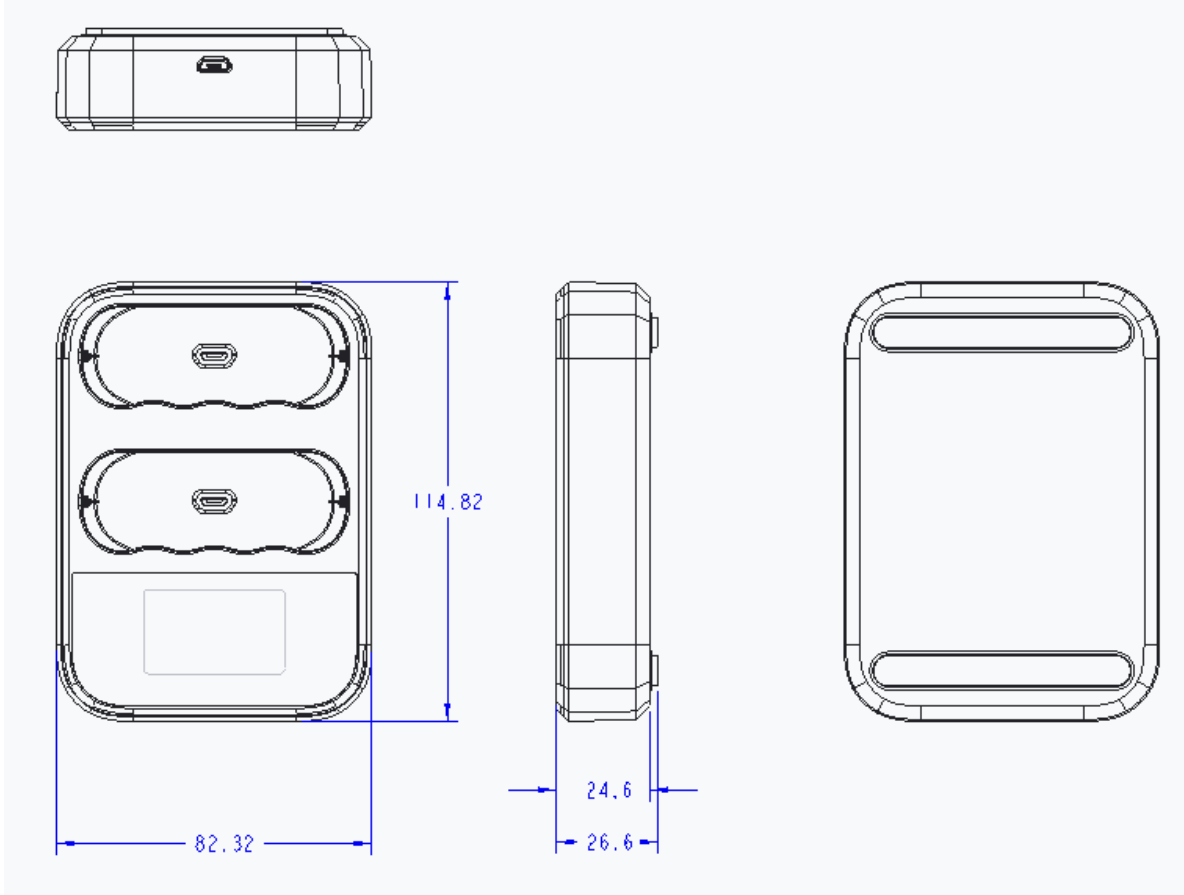

---

Product Name	:	USB 8-Slot Charging Dock <b>D851</b>
Input	:	DC5V 2.1A
Applicable Charger	:	1 or 2 pcs of USB 4-slot Charger of B421, M421 and/or P421
Operation Temperature	:	0°C to 33°C
Dimensions	:	114.8 (L) x 82.3 (W) x 26.6 (H) mm
Weight	:	100.5 g (approx.)
Certification	:	CE, FCC, Rohs
Warranty Period	:	12 months from ex-factory date

# GP Batteries

## Product Specification

Model no.: D851

LCD Indication :

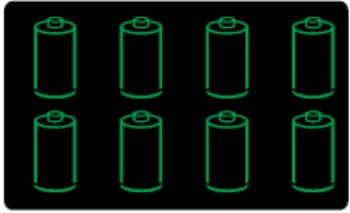
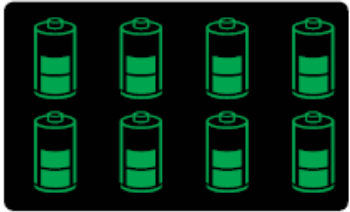
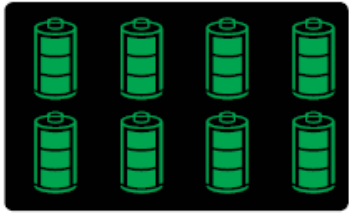
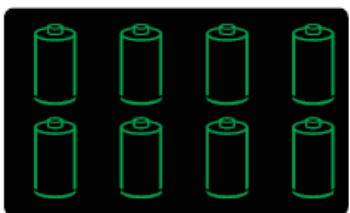
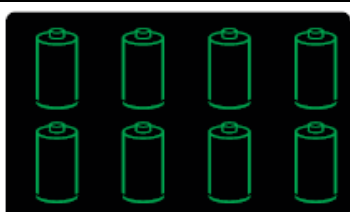
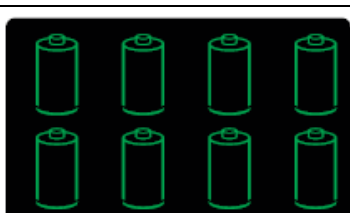
CONDITION	SCREEN DESCRIPTION	LCD STATES
Power on and no charger box inserted	8 Power block turn on	
Charging in progress	Corresponding battery power block flashing	
When charging is finished and then switch to trickle charge	Corresponding battery all power block invariability	
No battery in changer box slot	Corresponding battery icon on	
Changer box plug off	8 Batteries icon flashing 10s (f=0.5Hz)	
Bad/ Primary battery inserted	Corresponding battery icon flashing (f=2Hz)	

CONDITION	SCREEN DESCRIPTION	LCD STATES
Ageing battery	Corresponding warning icon turn on and battery power block flashing	